

Article number: 2032100M1050A1S

Description: E+G levelling foot  
GN 32-100-M10-50-A1-S

Note: S Without nut, External hexagon at the bottom

## Measures

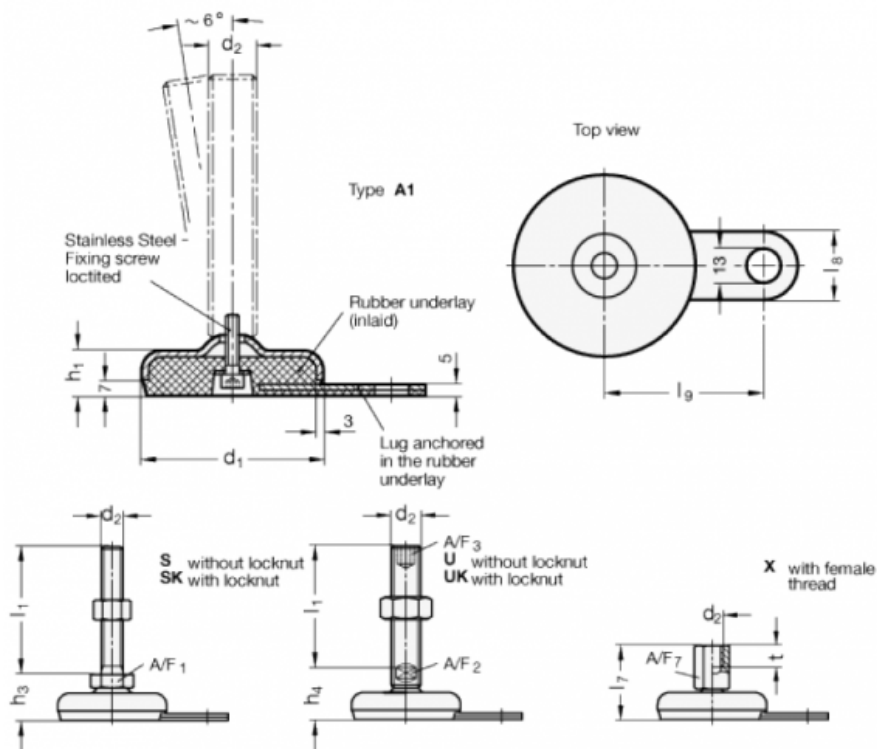

A/F1	= 17
d1	= 100
d2	= M10
h1	= 21
h3	= 29
l1	= 50
l8	= 30
l9	= 80